

Article number: 03485035
 Description: Fluro Rod end EIL 35D-2RS
 Note: 35

Measures

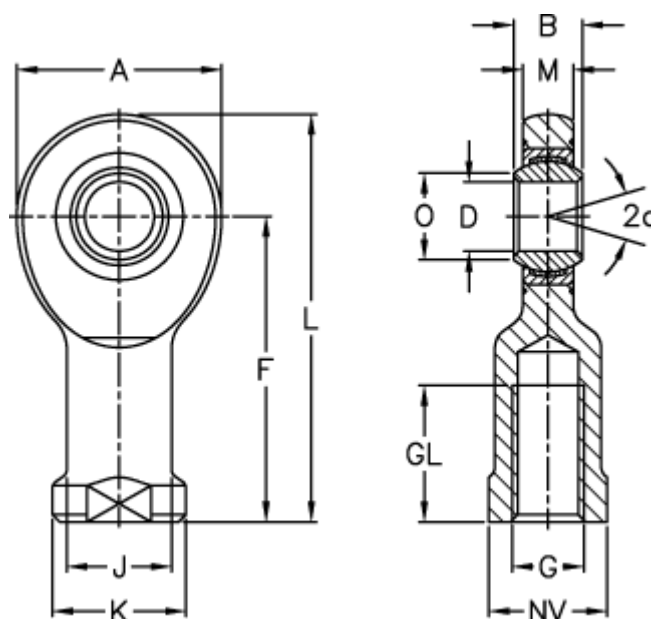

A	= 82	J	= 47
a (degrees)	= 6	K	= 58
B	= 25	L	= 166
D	= 35	M	= 21
Dynamic drive (kN)	= 140	NV	= 50
F	= 125	O	= 39.8
g	= M36x3	Static drive kN	= 144
GL	= 60	Weight	= 1300